

flarmMouse

The Smallest flarm with integrated GPS antenna

Version 1.0



LXNAV d.o.o. • Kidričeva 24a, 3000 Celje, Slovenia • tel +386 592 33 400 fax +386 599 33 522
info@lxnav.com • www.lxnav.com

1	Important Notices	3
1.1	Limited Warranty	3
2	Packing Lists	4
3	Basics	5
3.1	LXNAV FlarmMouse at a Glance	5
3.1.1	LXNAV FlarmMouse Features	6
3.1.2	Interfaces	6
3.1.3	Options	6
3.1.4	Technical Data	6
4	System Description	7
4.1.1	Push Button	7
4.2	Switching on the Unit	7
4.3	Normal operation	7
4.4	Description of LED's on FlarmMouse	7
5	Installation	8
5.1	Connecting LXNAV FlarmMouse	8
5.2	Wiring	8
5.2.1.1	FlarmMouse pinout	8
5.2.1.2	FlarmMouse - FlarmView	9
5.2.1.3	FlarmMouse - FlarmLED	9
5.2.1.4	FlarmMouse – FlarmLED - Oudie	10
	FlarmMouse - FlarmView -V7 - OUDIE	10
	FlarmMouse - FlarmView -V7 - OUDIE	11
6	Firmware Update	12
6.1	Firmware update via SD-Card	12
6.2	Firmware update with the PC flarmtools	12
6.2.1	Method 1: Standard	13
6.2.2	Method 2: only if method 1 fails	13
6.3	Update of the FlarmMouse settings	14
6.3.1	Changing settings via PC Flarmtools	14
6.3.2	Settings via configuration file	14
6.4	Saving flight on the SD-card	15
7	Revision History	16

1 Important Notices

The LXNAV FlarmMouse system is designed for VFR use only as an aid to prudent navigation. All information is presented for reference only.

Information in this document is subject to change without notice. LXNAV reserves the right to change or improve their products and to make changes in the content of this material without obligation to notify any person or organisation of such changes or improvements.



A Yellow triangle is shown for parts of the manual which should be read carefully and are important for operating the LXNAV FlarmMouse system.



Notes with a red triangle describe procedures that are critical and may result in loss of data or any other critical situation.



A bulb icon is shown when a useful hint is provided to the reader.

1.1 Limited Warranty

This LXNAV FlarmMouse product is warranted to be free from defects in materials or workmanship for two years from the date of purchase. Within this period, LXNAV will, at its sole option, repair or replace any components that fail in normal use. Such repairs or replacement will be made at no charge to the customer for parts and labour, the customer shall be responsible for any transportation cost. This warranty does not cover failures due to abuse, misuse, accident, or unauthorised alterations or repairs.

THE WARRANTIES AND REMEDIES CONTAINED HEREIN ARE EXCLUSIVE AND IN LIEU OF ALL OTHER WARRANTIES EXPRESSED OR IMPLIED OR STATUTORY, INCLUDING ANY LIABILITY ARISING UNDER ANY WARRANTY OF MERCHANTABILITY OR FITNESS FOR A PARTICULAR PURPOSE, STATUTORY OR OTHERWISE. THIS WARRANTY GIVES YOU SPECIFIC LEGAL RIGHTS, WHICH MAY VARY FROM STATE TO STATE.

IN NO EVENT SHALL LXNAV BE LIABLE FOR ANY INCIDENTAL, SPECIAL, INDIRECT OR CONSEQUENTIAL DAMAGES, WHETHER RESULTING FROM THE USE, MISUSE, OR INABILITY TO USE THIS PRODUCT OR FROM DEFECTS IN THE PRODUCT. Some states do not allow the exclusion of incidental or consequential damages, so the above limitations may not apply to you. LXNAV retains the exclusive right to repair or replace the unit or software, or to offer a full refund of the purchase price, at its sole discretion. SUCH REMEDY SHALL BE YOUR SOLE AND EXCLUSIVE REMEDY FOR ANY BREACH OF WARRANTY.

To obtain warranty service, contact your local LXNAV dealer or contact LXNAV directly.

2 Packing Lists

- FlarmMouse
- Dipole FlarmAntenna
- Micro SD card
- Flarm splitter
- Flarm power supply cable
- FlarmView/FlarmLED (Optional)

3 Basics

3.1 LXNAV FlarmMouse at a Glance

FlarmMouse is standalone Flarm[®] with integrated GPS antenna, Micro SD card. It's a collision avoidance device, designed for gliders as well as for other participants in the air. FLARM[®] is in widespread use and features include:

- Display of nearby Flarm traffic with warning visually and acoustically of approaching other aircraft or fixed obstacles (where database has been installed)
- intelligent motion prediction which minimizes nuisance alarms and supports situational awareness
- integration with over 50 compatible products by other manufacturers (e.g. PDA moving maps) through open serial port protocol
- all versions feature microSD card for easy uploads and downloads, IGC-format flight recording and OLC-approval
- based on award-winning original FLARM[®] design, endorsed by FAI, IGC/OSTIV and EASA (AMC Part 21, Part M)
- optional diamond-level IGC-approval with/without engine noise sensor (ENL)
- a typical 4-8km radio range that can be verified with online radio range analyzer
- powerful 16-channel high-precision uBlox LEA6-GPS module
- embedded database that covers Italian, Swiss, Austrian, French and German obstacles, with updates (with periodic updates for which there is a charge)
- full compatibility with wide range of Flarm-licensed products
- operation on a license-free radio band, not based on transponder technology
- small size and simple installation

FlarmMouse is available in three variants:

1. FlarmMouse with Flight recorder (Not approved by IGC), with enabled SAR (search and rescue) function
2. FlarmMouse with IGC approved Flight recorder (Up to Diamonds) and SAR function
3. FlarmMouse with IGC approved Flight recorder (Up to Diamonds), Engine noise sensor and SAR function



3.1.1 LXNAV FlarmMouse Features

- Internal SD card for configuration of Flarm, firmware update or storing IGC flights
- IGC flight recorder (Up To Diamond level)
- Optionaly preloaded obstacles (where databases are available) – Obstacles are not any more free of charge.
- Expandable to all standard Flarm displays
- Designed for FlarmView
- Low current consumption

3.1.2 Interfaces

- Standard Flarm/IGC port on RJ45 with serial RS232 interface
- 5 LED's to indicate Flarm statuses



Default baudrate of FlarmMouse is set to 19200bps. In case, that you have any problems with flarm indicator (FlarmView), please check baudrate setting on it.

3.1.3 Options

One or more external Flarm Displays can be connected (FlarmView/FlarmLED)

3.1.4 Technical Data

- Power input 6-18 V DC
- Consumption 36mA@12V
- Weight 40 g
- 65mm x 42mm x 13mm

4 System Description

4.1.1 Push Button

Push button has only function in case of firmware update using FlarmTool.

4.2 Switching on the Unit

Unit is switched on automatically, when get power supply.

4.3 Normal operation

FlarmMouse is in normal operating mode, when receives signals from enough GPS satellites. Then became visible for other flarm devices.

4.4 Description of LED's on FlarmMouse



This leds are not designed to be used to indicate flarm status in flight. They can be very useful in case of troubleshooting.

5 Installation

FlarmMouse can be installed to the top of the instrument panel or below, if cover is not made of carbon.



For better range, Flarm antenna must be positioned vertically.

5.1 Connecting LXNAV FlarmMouse

LXNAV FlarmMouse is connected to 12V DC power supply using FlarmPower cable. Red wire goes to + positive and blue wire goes to – ground. External indicator is connected via flarm splitter.



Instrument has no internal fuse. **3A external fuse is required!**

5.2 Wiring

5.2.1.1 FlarmMouse pinout



Pin number	Description
1	(Power input) 12VDC
2	(Power output) 3.3VDC (200mA)
3	GND
4	(output) Data out RS232 – transmit line
5	(input) Data in RS232 – receive line
6	Ground

5.2.1.2 FlarmMouse - FlarmView

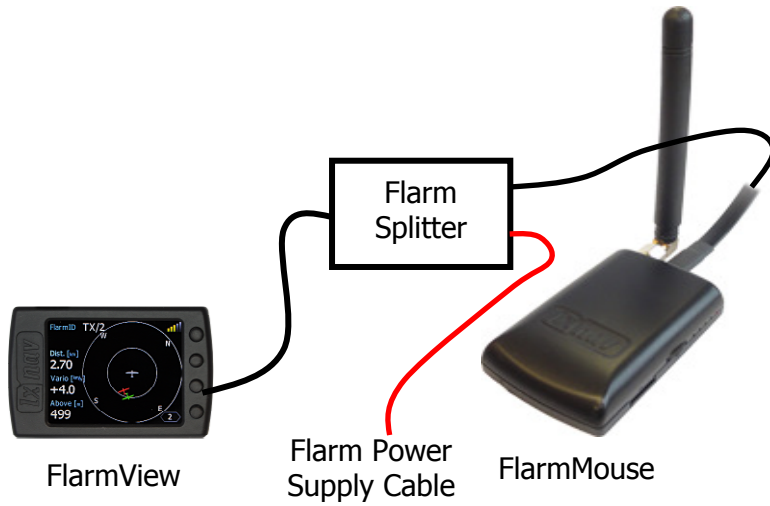

5.2.1.3 FlarmMouse - FlarmLED

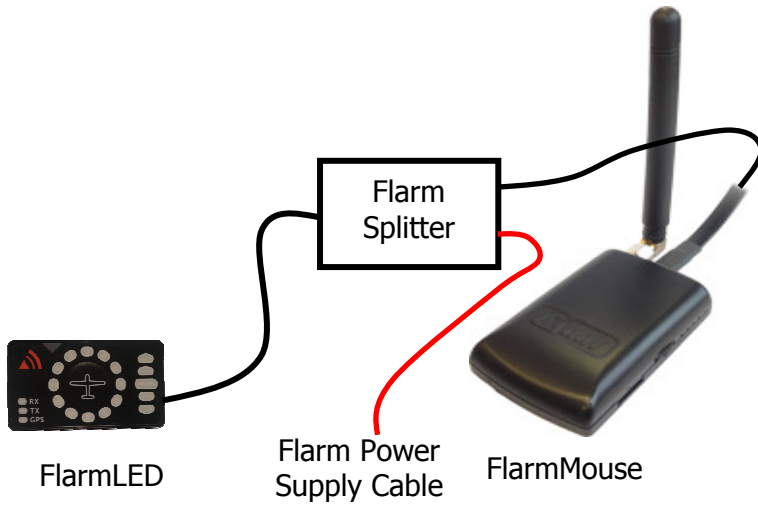

5.2.1.4 FlarmMouse – FlarmLED - Oudie

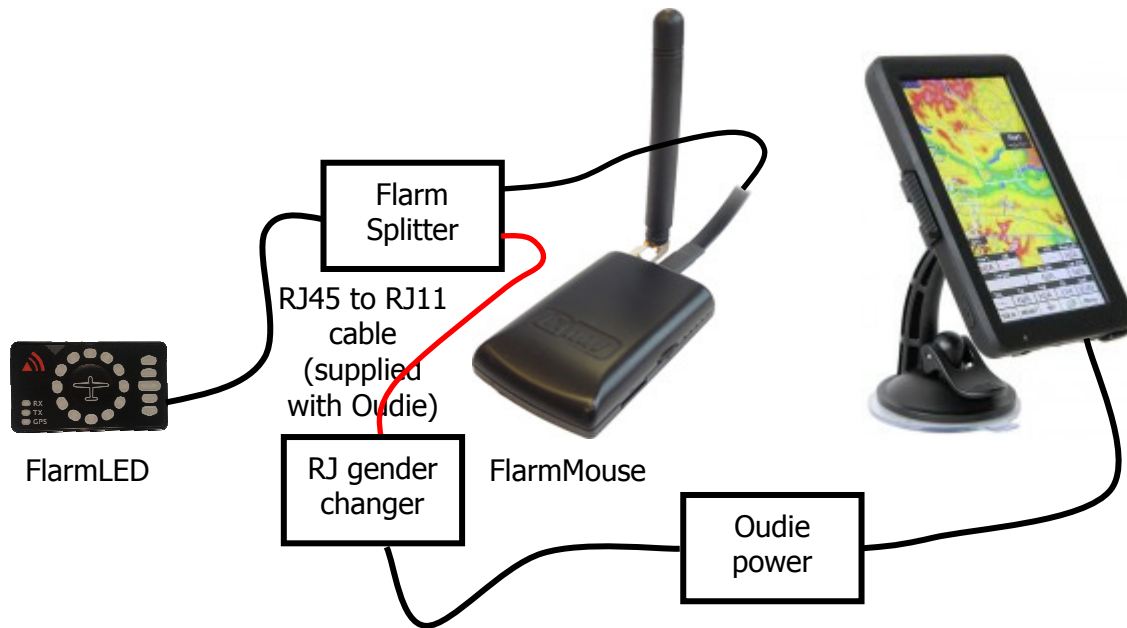

FlarmMouse - FlarmView -V7 - OUDIE

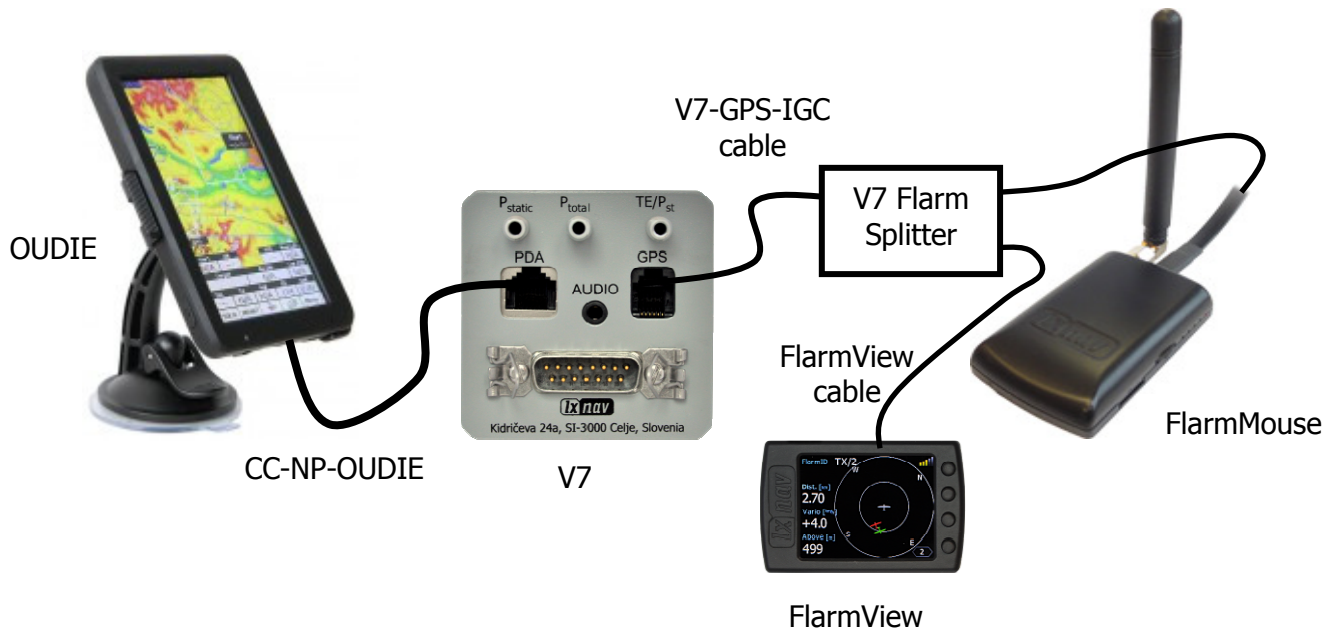

6 Firmware Update

6.1 Firmware update via SD-Card

This Method is the easiest one and therefore preferred

The firmware update will be executed, when the system finds the file named `flarm_x*.fw` (x= version nr.) on the SD-card root. This file can be downloaded at www.flarm.com.

Update procedure:

- Switch off the Flarm and insert the SD-card.
- Now switch on the device
- the procedure will start automatically, it takes about one minute.
- When ready, switch off the Flarm
- Please delete the firmware file from the SD-card after the update

Updating the obstacle database:

The firmware update will be executed, when the system finds a file with the extension `*.obs` on the SD-card root. The procedure runs identically to the firmware update and takes a few minutes. Please delete the obstacle file from the SD-card after the update

All data must be in the SD-card root directory, folder/subfolder are not allowed. Names of the files shall not be changed.

6.2 Firmware update with the PC flarmtools

This method is necessary only, if the update via SD-card fails. In this case you will need the Flarm update cable (does not belong to the standard scope of delivery).

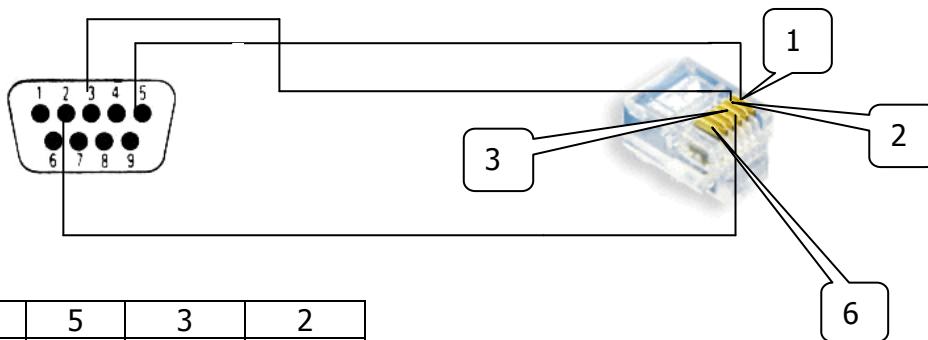

SUB D 9P	5	3	2
RJ 11 (6P)	1	2	3

Flarm update cable



The update cable does not belong to the standard scope of delivery.

Current version of the PC flarmtools is V2.00, containing Flarm firmware V5.09

6.2.1 Method 1: Standard

- Switch on Flarm (Connect to power)
- Start the flarmtool on your PC/Notebook (contains current firmware)
- Now connect the FlarmMouse with PC /Notebook. (via splitter)
- Connection will establish automatically
- After confirming license agreements, the update will start.
- When finished, switch off the FlarmMouse

6.2.2 Method 2: only if method 1 fails

- Switch the FlarmMouse off (disconnect power)
- Start actual FLARM-Tool (contains current firmware) on your PC/Notebook
- Now connect the FlarmMouse with PC /Notebook. (via splitter).
- Choose „recover“ under the menu item Flarm

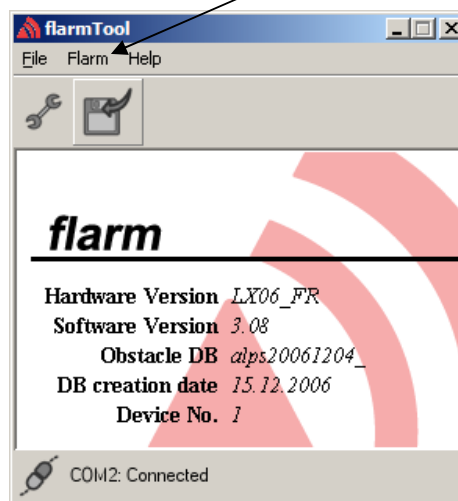

- Now press and hold the push button of the FlarmMouse and connect power
- Release the push button as soon as the update bar starts to run.
- When finished, switch off the FlarmMouse

Under the menu item „Flarm“ you will also find the possibility to update the obstacle database and to change settings in your FlarmMouse.



The FLARM firmware expires periodically. Performing an upgrade is obligatory then. Information about this you will find under www.flarm.com

6.3 Update of the FlarmMouse settings

6.3.1 Changing settings via PC Flarmtools

Please use the item **Settings** in the „Flarm“ menu

Besides other settings you will find the possibility to set the baud rate of the FlarmMouse (e.g. if you connect it to a V7, you might use a higher baud rate than the default 19200bps)

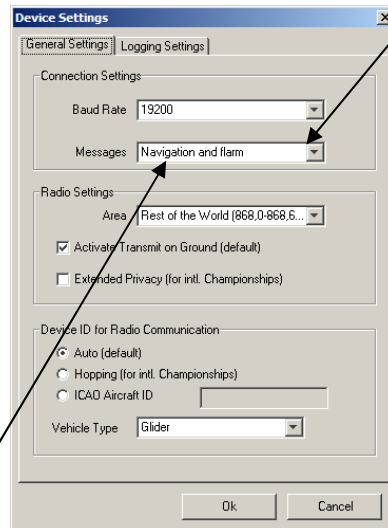

Choose **“Navigation and Flarm”** under Messages, if you like to have NMEA-data additionally to the Flarm data. This is necessary, when the FlarmMouse is used as GPS source for navigational systems (V7, LX8xxx simple,...), graphical flarmdisplays (FlarmView,...) or PDA/PNA (Oudie,...). For the FlarmMouse this setting is default..

6.3.2 Settings via configuration file

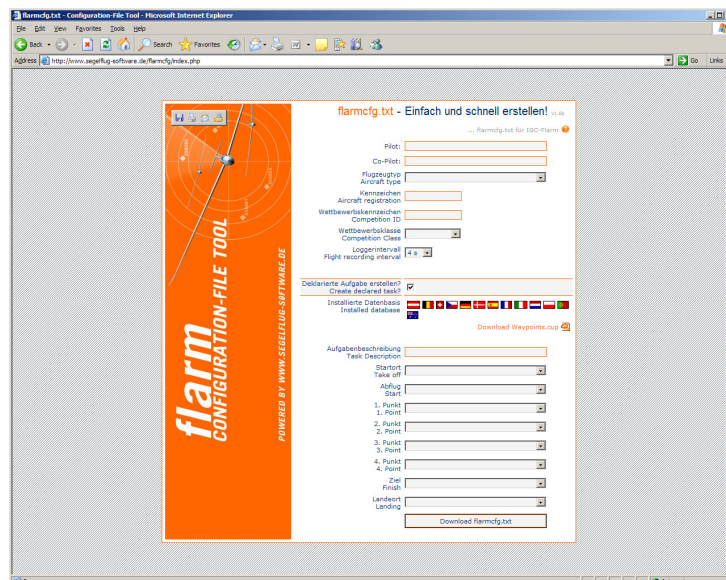

Settings of you FlarmMouse and declaration of flights can easily be performed by using a configuration file, which is read by the Flarm during the boot process (flarmcfg.txt). Some tools for a simple writing of such configuration files can be found in the web, here one example: www.segelflug-software.de/flarmcfg/.

The configuration can also be performed with PC programs like SeeYou or PDA solutions like ConnectME and Pocket StrePla.

6.4 Saving flight on the SD-card

The last 20 flights will be downloaded at every switching on (only if the SD card is inserted). If there are already some of the 20 flights on the SD-card, they will not be downloaded again. That means: if you have been flying a lot without downloading flights, the download procedure will take some time, so don't switch off. To download one flight after landing perform the following procedure: Wait a few minutes after landing (more than 3). Then switch off for at least 5 sec. Insert SD-card (in case its not already inside) and switch on again.



The collision avoidance functionality does not depend on the status of the SD-card (inserted or not)



The system cannot work with FAT 32 formatted SD-cards. Please use FAT16 formatted cards. The SD-card, which is delivered with the FlarmMouse is ready to use.

7 Revision History

January 2013	Initial release of owner manual
May 2013	Added pinout
June 2013	Added new configuration Ch.5.2.1.4
October 2013	Added chapter 6.1 - 6.4